

User Manual

SKU: ABX00042-ABX00045-ABX00046

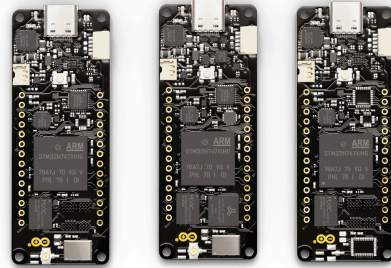

Description

Portenta H7 family runs high level codes along with real time tasks thanks to the two processors that makes it possible to run tasks in parallel. For example, it is possible to execute Arduino compiled code along with MicroPython one simultaneously, and have both cores to communicate with one another.

Within the H7 family, there are two variants; H7 Lite and H7 Lite Connected. All the three boards and their differences are presented in this datasheet.

Target Areas:

Laboratory equipment, Computer vision

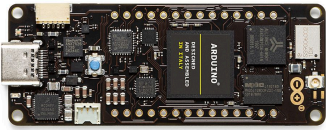
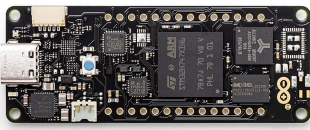
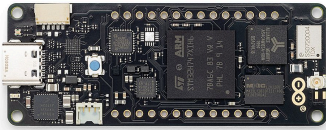
Name	Portenta H7	Portenta H7 Lite	Portenta H7 Lite Connected
SKU	ABX00042	ABX00045	ABX00046
Preview			
Security	ATECC608 NXP SE050C2	ATECC608	ATECC608
Connectivity	Ethernet PHY / Wi-Fi® / Bluetooth® Low Energy (BLE 5 via Cordio stack, BLE 4.2 via Arduino Stack)	Ethernet PHY	Ethernet PHY / Wi-Fi® / Bluetooth® Low Energy (BLE 5 via Cordio stack, BLE 4.2 via Arduino Stack)
Memory	8 MB SDRAM / 16 MB QSPI Flash	8 MB SDRAM / 16 MB QSPI Flash	8 MB SDRAM / 16 MB QSPI Flash
Power	Li-Po Single Cell 3.7V, 700mAh Minimum	Li-Po Single Cell 3.7V, 700mAh Minimum	Li-Po Single Cell 3.7V, 700mAh Minimum

CONTENTS

1 Features	5
1.1 Microcontroller	5
1.2 Memory	8
1.3 USB	8
1.4 HD Connectors	8
1.5 Crypto Chip	9
1.6 Secure Element	9
1.7 MKR Compatibility	10
1.8 ESLOV	10
1.9 Power Management	10
2 Ratings	11
2.1 Recommended Operating Conditions	11
2.2 Power Consumption	11
2.3 Block Diagram	11
3 Connector Pinouts	12
3.1 USB-C®	12
3.2 High Density Connector	13
3.3 I2C Ports	14
3.4 Wake Up Signals/External Relay Commands	15
4 Application Examples	16
4.1 Accessories (Not Included)	16
5 Functional Overview	16
5.1 Board Topology	16
5.2 Power Tree	17
6 Mean Time Between Failure (MTBF)	18
7 Mechanical Information	18
7.1 Board Outline	18
7.2 Mounting Holes	19
7.3 Connector Positions	19
8 Certifications	21
8.1 Declaration of Conformity CE DoC (EU)	22
8.2 Declaration of Conformity to EU RoHS & REACH 211 01/19/2021	22
8.3 Conflict Minerals Declaration	23

9 FCC Caution	23
10 Company Information	24
11 Reference Documentation	24
12 Revision History	24

1 Features

1.1 Microcontroller

Component	Details		Supported boards
ST STM32H747XI Processor	Dual Core	<p>Arm® Cortex®-M7 core at up to 480 MHz with double-precision FPU and 16K data + 16K instruction L1 cache</p> <p>Arm® 32-bit Cortex®-M4 core at up to 240 MHz with FPU, Adaptive real-time accelerator (ART Accelerator™)</p>	All
	Flash Memory	<p>2Mbytes of Flash Memory with read-while-write support</p> <p>1 Mbyte of RAM</p>	
	Dual mode Quad-SPI memory interface running up to 133 MHz		
	CRC calculation unit		
	Security		
	ROP, PC-ROP, active tamper		
	3 separate power domains. Possible to be independently clock gated or switched off.	<p>D1: high performance capabilities</p> <p>D2: communication peripherals and timers</p> <p>D3: reset/clock control/power management</p>	
	Voltage scaling in Run and Stop mode 6 configurable ranges		
	4 DMA controllers to unload the CPU		
	1x high-speed master direct memory access controller (MDMA) With linked list support		
	2x Dual-port DMA with FIFO		
	1x basic DMA with request router capabilities		

Component	Details		Supported boards
	Up to 35 communication peripherals	4× I2Cs FM+ interfaces (SMBus/PMBus) 4× USARTs/4x UARTs (ISO7816 interface, LIN, IrDA, up to 12.5 Mbit/s) and 1x LPUART 6× SPIs, 3 with muxed duplex I2S audio class accuracy via internal audio PLL or external clock, 1x I2S in LP domain (up to 150 MHz) 4x SAIs (serial audio interface) SPDIFRX interface SWPMI single-wire protocol master I/F MDIO Slave interface 2× SD/SDIO/MMC interfaces (up to 125 MHz) 2× CAN controllers: 2 with CAN FD, 1 with time-triggered CAN (TT-CAN) 2× USB OTG interfaces (1FS, 1HS/FS) crystal-less solution with LPM and BCD Ethernet MAC interface with DMA controller	
	8-bit camera interface (up to 80 MHz)		
	11 analog peripherals		
	3x ADCs with 16-bit max. resolution (up to 36 channels, up to 3,6 MSPS)		
	1x temperature sensor		
	2x 12-bit D/A converters (1 MHz)		
	2x ultra-low power comparators		
	2x operational amplifiers (7.3 MHz bandwidth)		
	1x digital filters for sigma delta modulator (DFSDM) with 8 channel/4 filters		
	Graphics		

Component	Details		Supported boards
	Chrom.ART graphical hardware Accelerator™ (DMA2D) to reduce CPU load		
	Hardware JPEG Codec		
	Up to 22 timers and watchdogs		
	1x high-resolution timer (2.1 ns max resolution)		
	2x 32-bit timers with up to 4 IC/OC/PWM or pulse counter and quadrature (incremental) encoder input (up to 240 MHz)		
	2x 16-bit advanced motor control timers (up to 240 MHz)		
	10x 16-bit general-purpose timers (up to 240 MHz)		
	5x 16-bit low-power timers (up to 240 MHz)		
	4x watchdogs (independent and window)		
	2x SysTick timers		
	RTC with sub-second accuracy and hardware calendar		
	True random number generators (3 oscillators each)		
	96-bit unique ID		

1.2 Memory

Component	Details		Supported boards
External memories	SDRAM	8 MByte	All
	QSPI Flash	16 MByte	

1.3 USB

Component	Details	Supported boards
USB-C®	High speed (optional/FULL Speed USB)	All
	Host and Device operation	
	Power Delivery support (optional)	
	DisplayPort	H7 full

1.4 HD Connectors

Component	Details	Supported boards
High Density connectors	1x10/100 Ethernet with PHY	All
	1x CAN	
	4x UART (2 with flow control)	
	3x I2C	
	1x SD Card	
	1x SPI	
	1x I2S	
	1x PDM input	
	2 lane MIPI DSI output	
	8 bit parallel camera interface	
	10x PWM output	
	7x GPIO	
	8x ADC inputs with separate VREF	

1.5 Crypto Chip

Component	Details	Supported boards
ATECC608 Microchip® Crypto (optional)	Protected storage for up to 16 Keys, certificates or data	All
	Hardware support for asymmetric sign, verify, key agreement – ECDSA: FIPS186-3 Elliptic Curve Digital Signature	
	ECDH: FIPS SP800-56A Elliptic Curve Diffie-Hellman	
	NIST standard P256 elliptic curve support	
	Hardware support for symmetric algorithms	
	SHA-256 & HMAC hash including off-chip context save/restore	
	AES-128: encrypt/decrypt, galois field multiply for GCM	
	Networking key management support	
	Turnkey PRF/HKDF calculation for TLS 1.2 & 1.3	
	Ephemeral key generation and key agreement in SRAM – Small message encryption with keys entirely protected	
	Secure boot support	
	Full ECDSA code signature validation, optional stored digest/signature – optional communication key disablement prior to secure boot	
	Internal high-quality FIPS 800-90 A/B/C Random Number Generator (RNG)	
Two high-endurance monotonic counters		
Guaranteed unique 72-bit serial number		

1.6 Secure Element

Component	Details	Supported boards
SE050C2 Secure element	Ready-to-use IoT secure element solution	H7 full
	Securely storing and provisioning credentials and performing cryptographic operations	
	based on NXP's Integral Security Architecture 3.0™	
	CC EAL 6+ certified HW	
	FIPS 140-2 certified platform with Security Level 3	
	Support for RSA and ECC asymmetric cryptography algorithms	
	Support for SCP03 protocol	
	up to 100 Mio write cycles / 25 years	

1.7 MKR Compatibility

Component	Details	Supported boards
MKR compatible header	7x PWM channels	All
	7x ADC channels	
	1x SPI	
	1x UART	
	1x I2C	

1.8 ESLOV

Component	Details	Supported boards
ESLOV Connector	I2C port with automatic device enumeration	All

1.9 Power Management

Component	Details	Supported boards
NXP PF1550 Programmable PMIC	Dynamic voltage scaling	All
	Programmable independent	
	1A voltage output to carrier board	
	Programmable I/O voltage	
	Integrated Li-Po/Li-Ion Battery charger	

2 Ratings

2.1 Recommended Operating Conditions

Symbol	Description	Min	Max
	Conservative thermal limits for the whole board:	-40 °C (-40 °F)	85 °C (185 °F)

2.2 Power Consumption

Description	Min	Typ	Max	Unit
Current consumption in deep sleep mode (@3.7V)		0.67		mA
Current consumption in busy loop (@5V)		2.6		mA
Maximum current consumption with M7 ON and M4 ON blinking (@5V)		230		mA

Note: All the measurements have been performed with Portenta H7 full version (ABX00042). The current consumption in busy loop has been evaluated according to the following loop:

1. Deep sleep mode.
2. Wake up every 595 seconds.
3. Acquire data for 5 seconds.
4. Go back to deep sleep mode.

2.3 Block Diagram

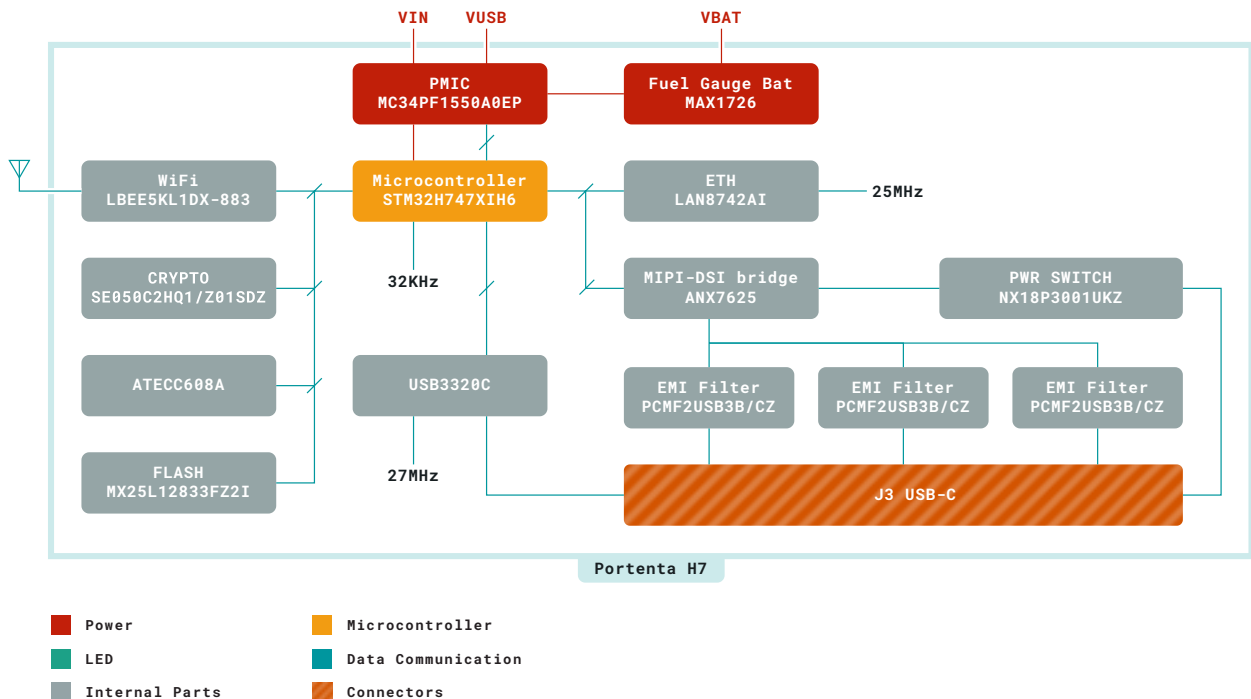

Block diagram

3 Connector Pinouts

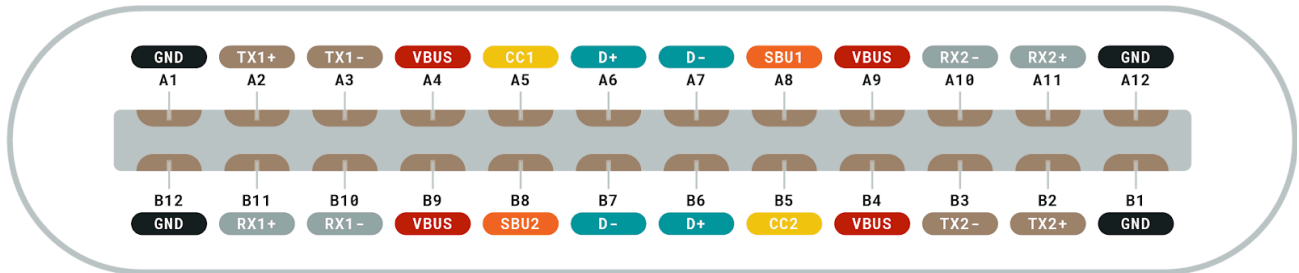

- Cable ground
- Cable bus power
- USB 2.0 Interface
- High speed data path (TX for USB, or RX for DP Alt Mode)
- High speed data path (RX for USB, or TX for DP Alt Mode)
- For sideband use (Not used for USB)
- Plug configuration detection
 - One becomes VCONN, for cable or adaptor power
 - CC is used for USB-PD communication

USB-C® Pinout

3.1 USB-C®

Pin	Description	Pin	Description
GND	Cable Ground	TX1 +/- TX2 +/-	High speed data path (TX for USB, or RX for DP Alt Mode)
VBUS	Cable bus power	RX1 +/- RX2 +/-	High speed data path (TX for USB, or RX for DP Alt Mode)
D+/D-	USB 2.0 Interface	SBU1 SBU2	For sideband use (Not used for USB)
CC1 CC2	Plug configuration detection * One becomes VCONN for cable or adaptor power * CC is used for USB-PD communication		

3.2 High Density Connector

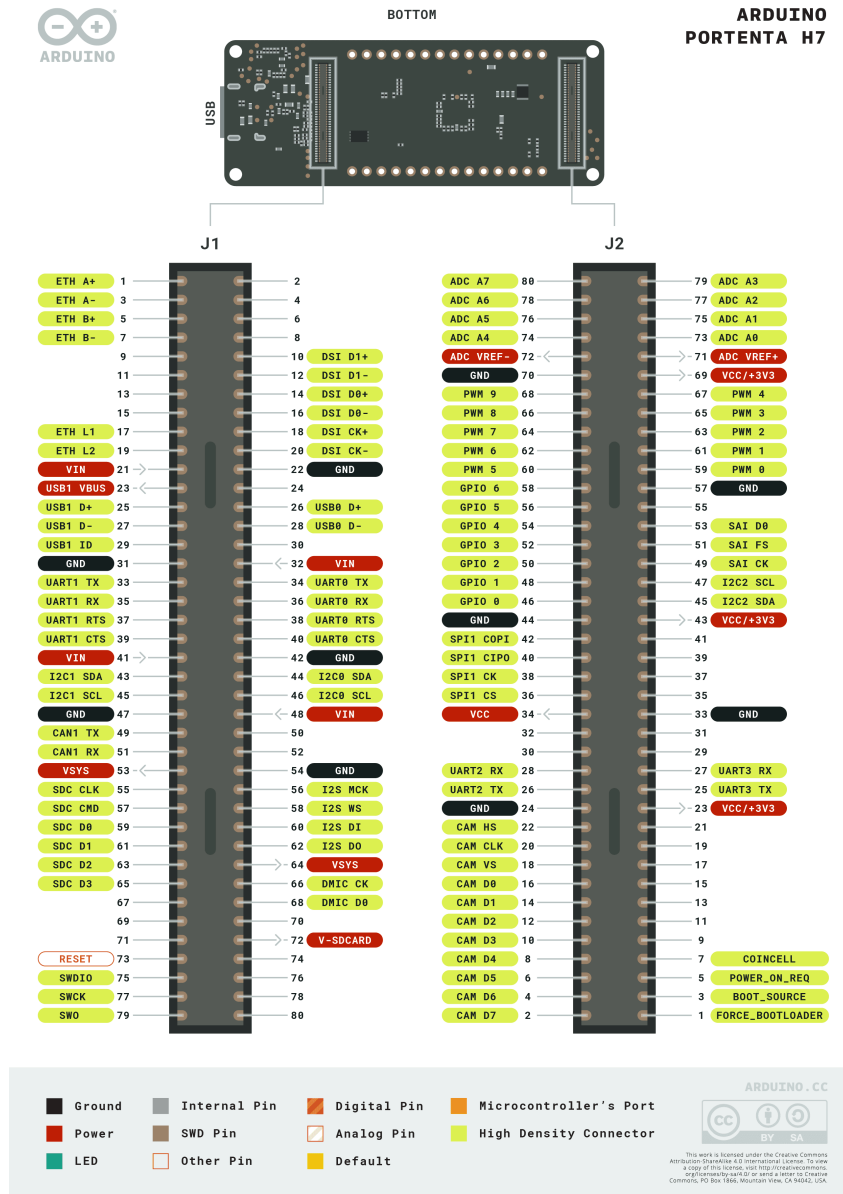

Legend:

- Ground
- Internal Pin
- Digital Pin
- Microcontroller's Port
- Power
- SWD Pin
- Analog Pin
- High Density Connector
- LED
- Other Pin
- Default

ARDUINO.CC

This work is licensed under the Creative Commons Attribution-ShareAlike 4.0 International License. To view a copy of this license, visit <http://creativecommons.org/licenses/by-sa/4.0/> or send a letter to Creative Commons, PO Box 1888, Mountain View, CA 94042, USA.

High density connectors pinouts

Pin	Description	Pin	Description
ETH	High Density Connector	CAN	High Density Connector
USB	High Density Connector	DSI	High Density Connector
CAM	High Density Connector	DMIC	High Density Connector
I2C0 I2C1 I2C2 I2S	High Density Connector	VSYS VIN V-SDCARD VCC VBUS USB ADC-VREF	Power

Pin	Description	Pin	Description
GND	Ground	PWM	High Density Connector
GPIO	High Density Connector	SPI1	High Density Connector
SWDIOSWCK SWO	High Density Connector	ADC	High Density Connector
SDC	High Density Connector	RESET	Other Pin

3.3 I2C Ports

System integrators can use the Portenta H7's High-Density connectors to expand signals of the board to a custom-designed daughter board or carrier. The following table summarizes the I2C pins mapping on the board's High-Density connectors and shared peripherals/resources. Please refer to the board's High-Density connectors pinout section.

HD Connector	Interface Name	Pins on HD	Status ¹	Shared Peripherals
J1	I2C1	43-45	Shared	Secure Element (0x48) PMIC (0x08) ANALOGX (0x54, 0x58, 0x70, 0x72, 0x7A, 0x7E, 0x48)
J1	I2C0	44-46	Free	
J2	I2C2	45-47	Shared	Camera (D1P-D1N)

¹Status column indicates the current status of the pins. "Free" means the pins are not in use by another resource or peripheral of the board and are available for usage, while "Shared" means the pins are used by one or several resources or peripherals of the board.

3.4 Wake Up Signals/External Relay Commands



ARDUINO PORTENTA H7

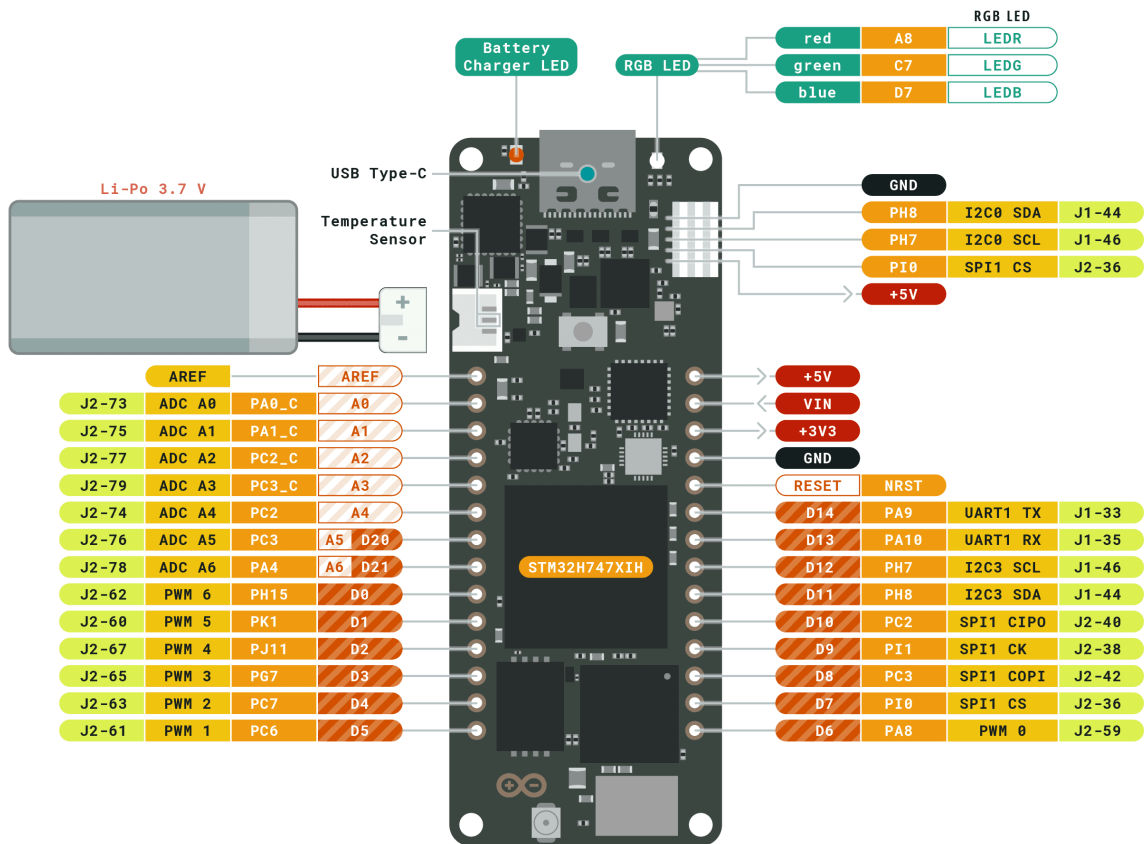

Ground	Internal Pin	Digital Pin	Microcontroller's Port
Power	SWD Pin	Analog Pin	High Density Connector
LED	Other Pin	Default	

ARDUINO.CC
CC BY SA
This work is licensed under the Creative Commons Attribution-ShareAlike 4.0 International License. To view a copy of this license, visit <http://creativecommons.org/licenses/by-sa/4.0/> or send a letter to Creative Commons, PO Box 1886, Mountain View, CA 94042, USA.

MRK format Headers pinout

4 Application Examples

Due to the dual core processing, the Portenta supports a wide array of applications.

4.1 Accessories (Not Included)

- USB 2.0 Cable Type A/B
- Portenta Vision Shield
- Portenta Breakout Board
- Portenta Max Carrier
- Portenta Hat Carrier

5 Functional Overview

5.1 Board Topology

Depending on the variant, some of the components does not apply. The image below originates from the H7 form factor, see what components are applied on your board:

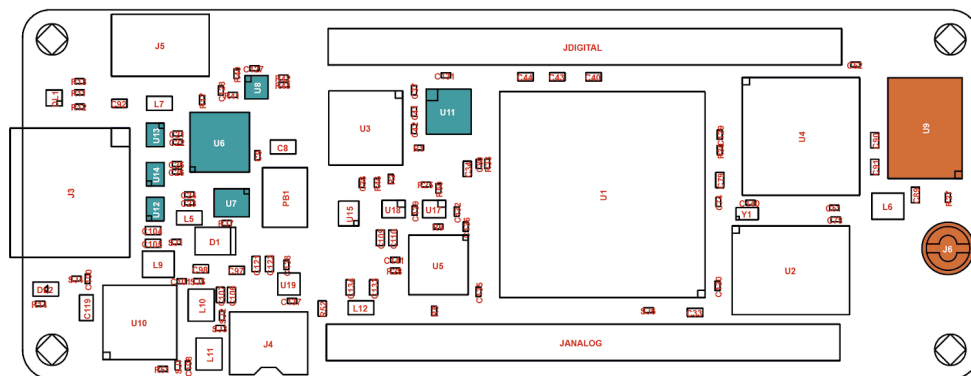

Only with Portenta H7



Only with Portenta H7 and Portenta H7 Lite Connected

Board Topology

Ref.	Description	Ref.	Description
U1	Main processor	U10	Power manager
U2	QSPI Flash memory	U11	Crypto chip (NXP®)*
U3	USB HS PHY	U12, U13, U14	ESD protection*
U4	SDRAM	U16	Crypto chip (Microchip®)
U5	Ethernet PHY	J1, J2	High Density connectors
U6	MIPI to USB-C®/DisplayPort converter*	ANT1	Antenna or U.FL connector**

Ref.	Description	Ref.	Description
U7	Level shifter*	JANALOG JDIGITAL	MKR compatible headers
U8	I2C level shifter*	J4	Battery connector
U9	Wi-Fi®/Bluetooth® module**	J5	ESLOV connector
J6	Micro UFL connector		

* = Only with Portenta H7

** = Only with Portenta H7 and Portenta H7 Lite Connected

5.2 Power Tree

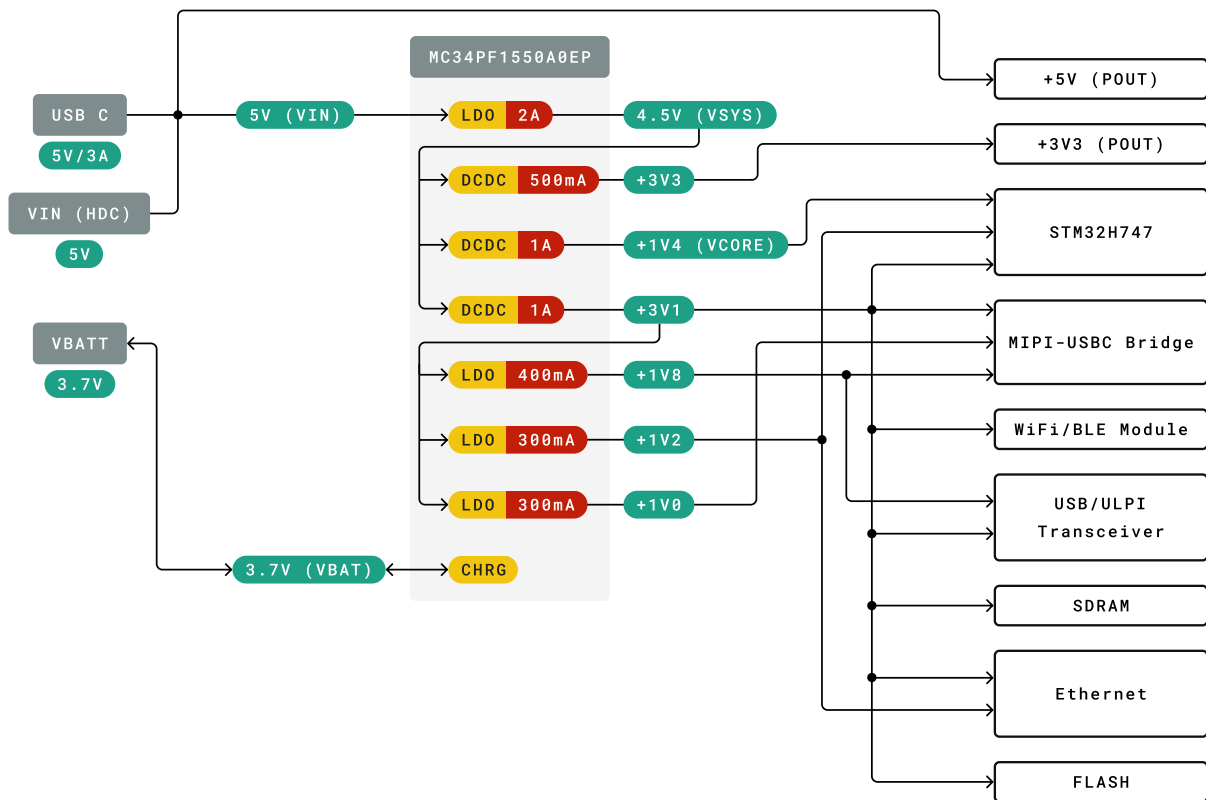

- Legend:
- Component
 - Power I/O
 - Conversion Type
 - Max Current
 - Voltage Range

Portenta H7 Power Tree

6 Mean Time Between Failure (MTBF)

MTBF, which stands for Mean Time Between Failure, is calculated according to statistical device failures and indicates the reliability of a device.

The MTBF figure (in hours/years) for the Portenta H7 (all variants) can be found in the table below. The MTBF figure was calculated according to the MIL-HDBK-217F part count method.

Standard	Portenta H7	Environmental Conditions
MIL-HDBK-217F	639717 h/73 years	25 °C

Important note: MTBF is the statistical representation of the likelihood of a unit failing and *does not necessarily represent a product's life*.

7 Mechanical Information

7.1 Board Outline

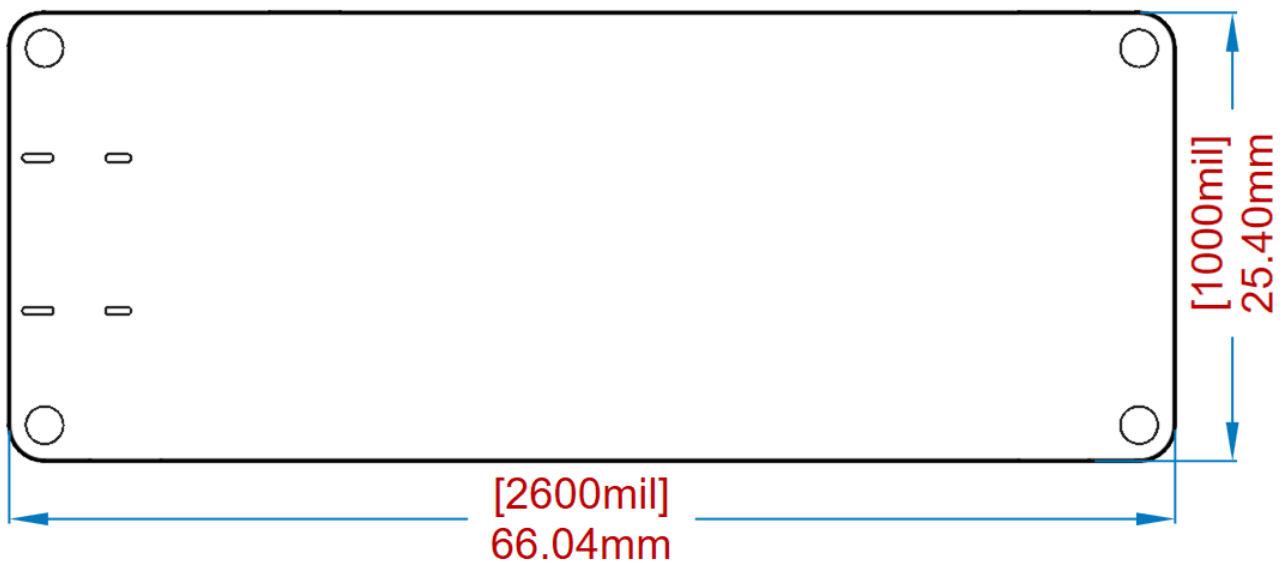

Board outline

7.2 Mounting Holes

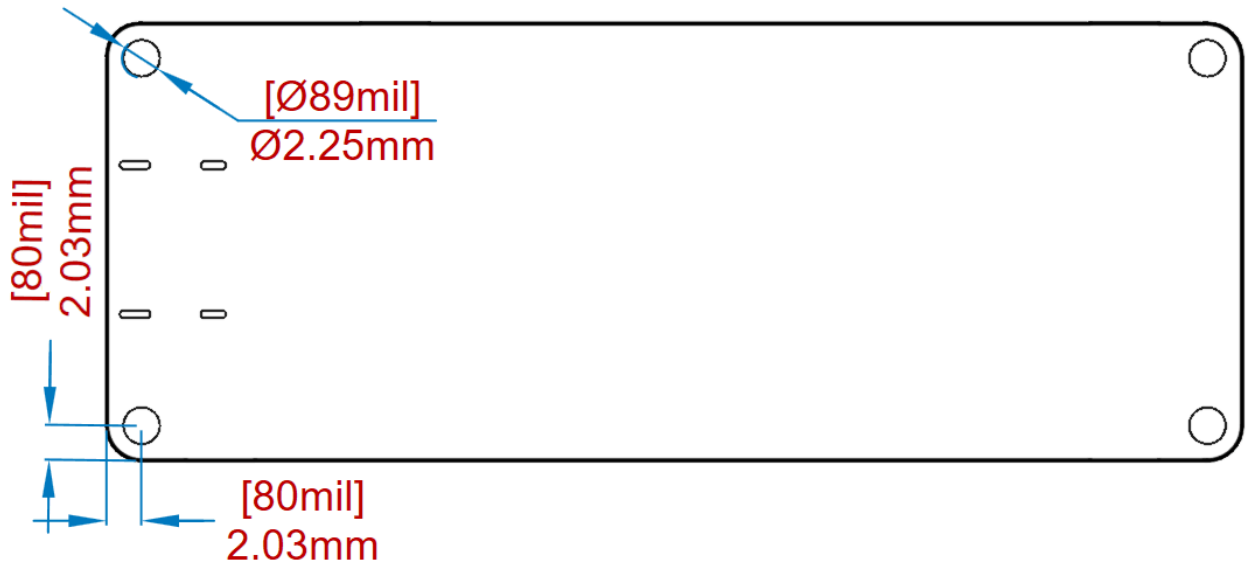

Mounting outline

7.3 Connector Positions

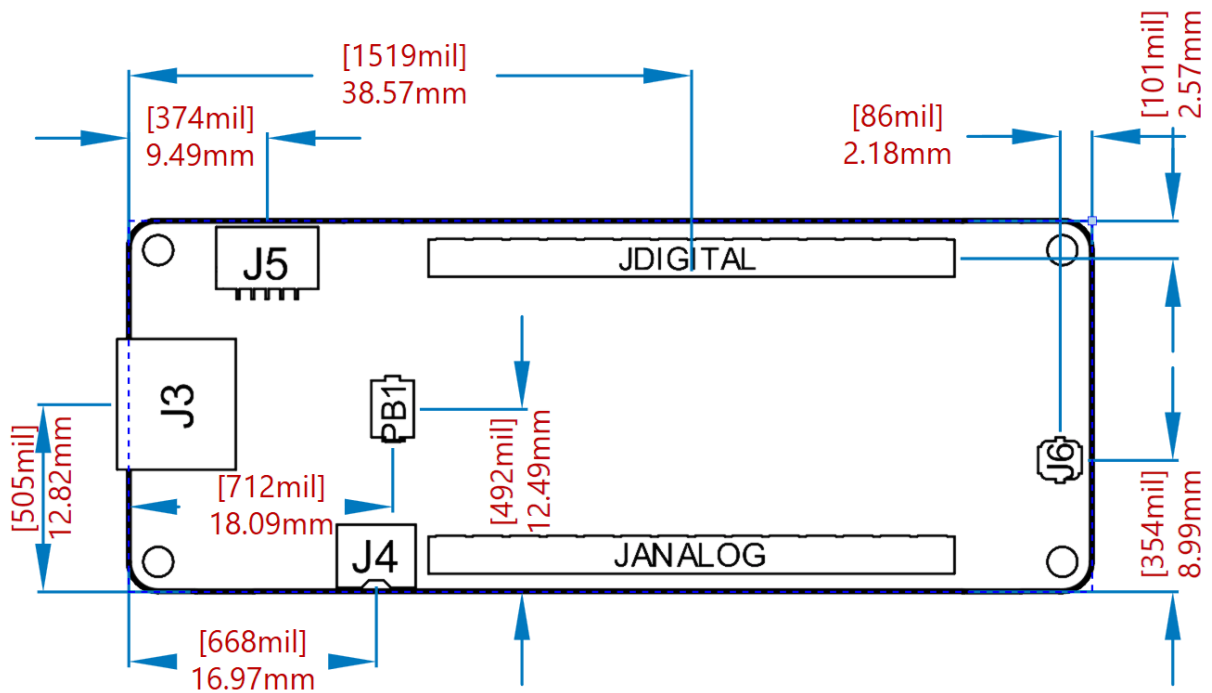

Connectors positions top

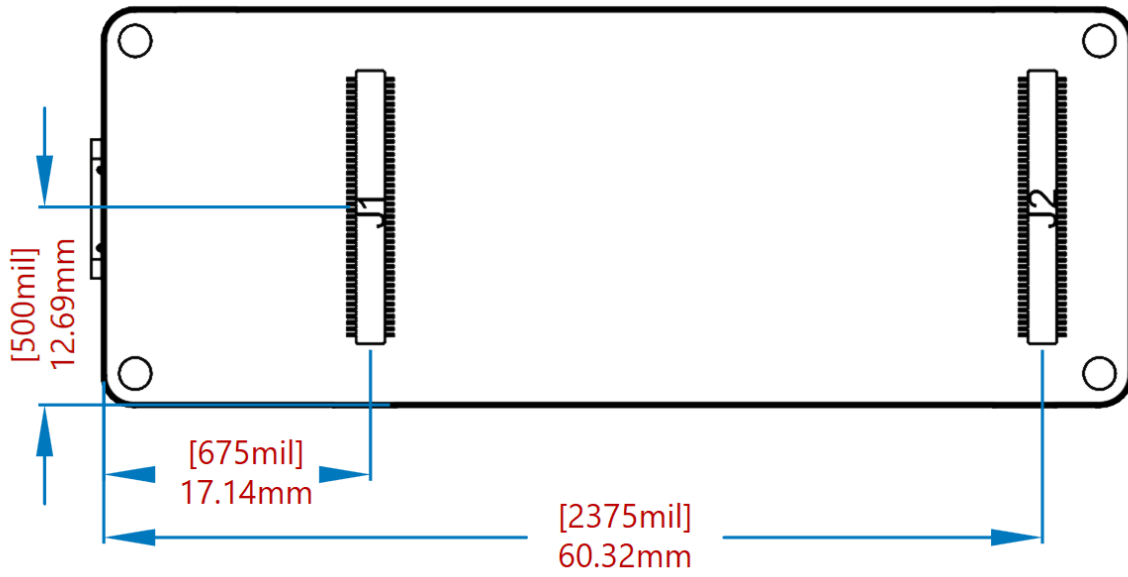

Connectors positions bottom

8 Certifications

Cert	H7	H7 Lite	H7 Lite Connected
CE (EU)	EN 301489-1, EN 301489-17, EN 300328, EN 62368-1, EN 62311	EN55032, EN 55035, EN 62368-1	EN 301489-1, EN 301489-17, EN 300328, EN 62368-1, EN 62311
WEEE (EU)	Yes	Yes	Yes
RoHS (EU)	2011/65/(EU) 2015/863/(EU)	2011/65/(EU) 2015/863/(EU)	2011/65/(EU) 2015/863/(EU)
REACH (EU)	Yes	Yes	Yes
UKCA (UK)	Yes	Yes	Yes
RCM (RCM)	Yes	Yes	Yes
FCC (US)	ID. Radio: Part 15-247 MPE: Part 2. 1091	SDoC. 47 CFR FCC Part 15 Subpart B	ID. Radio: Part 15-247 MPE: Part 2. 1091
IC (CA)	ID. Radio: RSS-247 MPE: RSS-102	X	X
RCM (AU)	Yes	Yes	Yes
SRRC (China) NO	X	X	X
MIC (Japan)	Article 2, Paragraph 1, Item 19	X	X

8.1 Declaration of Conformity CE DoC (EU)

We declare under our sole responsibility that the products above are in conformity with the essential requirements of the following EU Directives and therefore qualify for free movement within markets comprising the European Union (EU) and European Economic Area (EEA).

8.2 Declaration of Conformity to EU RoHS & REACH 211 01/19/2021

Arduino boards are in compliance with RoHS 2 Directive 2011/65/EU of the European Parliament and RoHS 3 Directive 2015/863/EU of the Council of 4 June 2015 on the restriction of the use of certain hazardous substances in electrical and electronic equipment.

Substance	Maximum limit (ppm)
Lead (Pb)	1000
Cadmium (Cd)	100
Mercury (Hg)	1000
Hexavalent Chromium (Cr6+)	1000
Poly Brominated Biphenyls (PBB)	1000
Poly Brominated Diphenyl ethers (PBDE)	1000
Bis(2-Ethylhexyl} phthalate (DEHP)	1000
Benzyl butyl phthalate (BBP)	1000
Dibutyl phthalate (DBP)	1000
Diisobutyl phthalate (DIBP)	1000

Exemptions : No exemptions are claimed.

Arduino Boards are fully compliant with the related requirements of European Union Regulation (EC) 1907 /2006 concerning the Registration, Evaluation, Authorization and Restriction of Chemicals (REACH). We declare none of the SVHCs (<https://echa.europa.eu/web/guest/candidate-list-table>), the Candidate List of Substances of Very High Concern for authorization currently released by ECHA, is present in all products (and also package) in quantities totaling in a concentration equal or above 0.1%. To the best of our knowledge, we also declare that our products do not contain any of the substances listed on the "Authorization List" (Annex XIV of the REACH regulations) and Substances of Very High Concern (SVHC) in any significant amounts as specified by the Annex XVII of Candidate list published by ECHA (European Chemical Agency) 1907 /2006/EC.

8.3 Conflict Minerals Declaration

As a global supplier of electronic and electrical components, Arduino is aware of our obligations with regards to laws and regulations regarding Conflict Minerals, specifically the Dodd-Frank Wall Street Reform and Consumer Protection Act, Section 1502. Arduino does not directly source or process conflict minerals such as Tin, Tantalum, Tungsten, or Gold. Conflict minerals are contained in our products in the form of solder, or as a component in metal alloys. As part of our reasonable due diligence Arduino has contacted component suppliers within our supply chain to verify their continued compliance with the regulations. Based on the information received thus far we declare that our products contain Conflict Minerals sourced from conflict-free areas.

9 FCC Caution

Any Changes or modifications not expressly approved by the party responsible for compliance could void the user's authority to operate the equipment.

This device complies with part 15 of the FCC Rules. Operation is subject to the following two conditions:

- (1) This device may not cause harmful interference
- (2) this device must accept any interference received, including interference that may cause undesired operation.

FCC RF Radiation Exposure Statement:

1. This Transmitter must not be co-located or operating in conjunction with any other antenna or transmitter.
2. This equipment complies with RF radiation exposure limits set forth for an uncontrolled environment.
3. This equipment should be installed and operated with minimum distance 20cm between the radiator & your body.

English: User manuals for licence-exempt radio apparatus shall contain the following or equivalent notice in a conspicuous location in the user manual or alternatively on the device or both. This device complies with Industry Canada licence-exempt RSS standard(s). Operation is subject to the following two conditions:

- (1) this device may not cause interference
- (2) this device must accept any interference, including interference that may cause undesired operation of the device.

French: Le présent appareil est conforme aux CNR d'Industrie Canada applicables aux appareils radio exempts de licence. L'exploitation est autorisée aux deux conditions suivantes :

- (1) l'appareil ne doit pas produire de brouillage
- (2) l'utilisateur de l'appareil doit accepter tout brouillage radioélectrique subi, même si le brouillage est susceptible d'en compromettre le fonctionnement.

IC SAR Warning:

English This equipment should be installed and operated with minimum distance 20 cm between the radiator and your body.

French: Lors de l'installation et de l'exploitation de ce dispositif, la distance entre le radiateur et le corps est d'au moins 20 cm.

Important: The operating temperature of the EUT can't exceed 85°C and shouldn't be lower than -40°C.

Hereby, Arduino S.r.l. declares that this product is in compliance with essential requirements and other relevant provisions of Directive 2014/53/EU. This product is allowed to be used in all EU member states.

Frequency bands	Maximum output power (ERP)
863-870Mhz	-3.22dBm

10 Company Information

Company name	Arduino SRL
Company address	Via Andrea Appiani, 25 - 20900 MONZA (Italy)

11 Reference Documentation

Reference	Link
Arduino IDE (Desktop)	https://www.arduino.cc/en/Main/Software

12 Revision History

Date	Revision	Changes
14/11/2024	7	Pinout information updated
06/02/2024	6	MTBF information
05/12/2023	5	Accessories section updated
17/10/2023	4	I2C ports information section added
27/01/2023	3	Add power consumption information
18/08/2022	2	Add Secure Element specs (SE050C2)
27/12/2021	1	First Release